

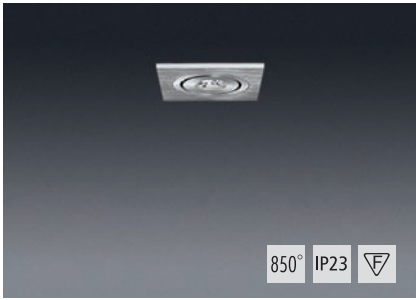

PULSAR 1

LED recessed light



Square recessed light with 1,2 W LED with 30° beam lens. Housing made of anodised aluminium. Adjustable. The 350 mA converter is not included in the product. Please order from page 417. Protection class III.

Version	grey anodised	Outer dimension	Ceiling cut-out	Recessed height
LED 1,2 W, 6500 K	300673	60 x 60 mm	53 x 53 mm	25 mm
LED 1,2 W, 2800 K	302187	60 x 60 mm	53 x 53 mm	25 mm

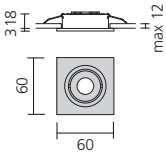

PULSAR 2

LED recessed light



Recessed light with decorative frame with 2 x 1,2 W LED with 30° beam lenses. Housing made of anodised aluminium. Adjustable. The 350 mA converter is not included in the product. Please order from page 417. Protection class III.

Version	grey anodised	Outer dimension	Ceiling cut-out	Recessed height
LED 2 x 1,2 W, 6500 K	300674	112 x 60 mm	105 x 53 mm	25 mm
LED 2 x 1,2 W, 2800 K	302188	112 x 60 mm	105 x 53 mm	25 mm

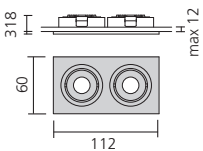

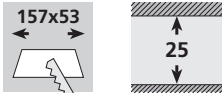

PULSAR 3

LED recessed light

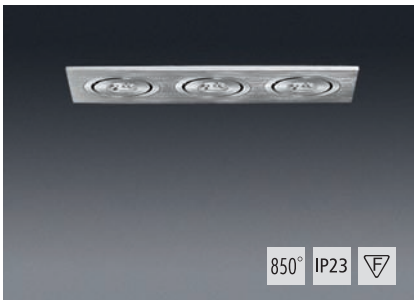

Recessed light with decorative frame with 3 x 1,2 W LED with 30° beam lenses. Housing made of anodised aluminium. Adjustable. The 350 mA converter is not included in the product. Please order from page 417. Protection class III.

Version	grey anodised	Outer dimension	Ceiling cut-out	Recessed height
LED 3 x 1,2 W, 6500 K	300675	164 x 60 mm	157 x 53 mm	25 mm
LED 3 x 1,2 W, 2800 K	302189	164 x 60 mm	157 x 53 mm	25 mm

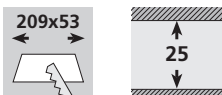
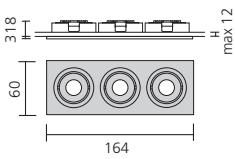

PULSAR 4

LED recessed light



Recessed light with decorative frame with 4 x 1,2 W LED with 30° beam lenses. Housing made of anodised aluminium. Adjustable. The 350 mA converter is not included in the product. Please order from page 417. Protection class III.

Version	grey anodised	Outer dimension	Ceiling cut-out	Recessed height
LED 4 x 1,2 W, 6500 K	300676	215 x 60 mm	209 x 53 mm	25 mm
LED 4 x 1,2 W, 2800 K	302190	215 x 60 mm	209 x 53 mm	25 mm

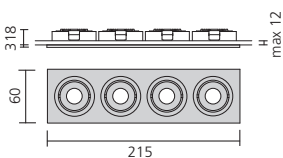



PULSAR 5

LED recessed light

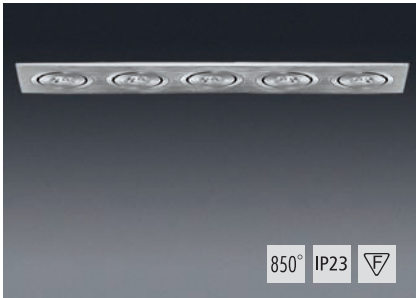

Recessed light with decorative frame with 5 x 1,2 W LED with 30° beam lenses. Housing made of anodised aluminium. Adjustable. The 350 mA converter is not included in the product. Please order from page 417. Protection class III.

Version	grey anodised	Outer dimension	Ceiling cut-out	Recessed height
LED 5 x 1,2 W, 6500 K	300677	268 x 60 mm	261 x 53 mm	25 mm
LED 5 x 1,2 W, 2800 K	302191	268 x 60 mm	261 x 53 mm	25 mm

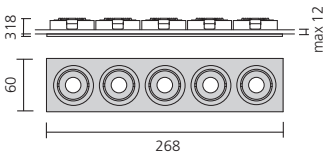

PULSAR 4 SQUARE

LED recessed light



Recessed light with square decorative frame with 4 x 1,2 W LED with 30° beam lenses. Housing made of anodised aluminium. Adjustable. The 350 mA converter is not included in the product. Please order from page 417. Protection class III.

Version	grey anodised	Outer dimension	Ceiling cut-out	Recessed height
LED 4 x 1,2 W, 6500 K	300678	112 x 112 mm	105 x 105 mm	25 mm
LED 4 x 1,2 W, 2800 K	302192	112 x 112 mm	105 x 105 mm	25 mm

