

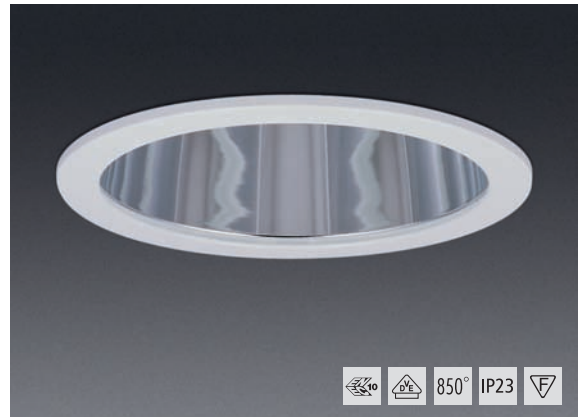

DL 255 modular – vertical lamp position

Round modular recessed downlight for TC-TEL / TC-TELI / TC-QELI lamps

Round modular recessed downlight for vertical TC-TEL / TC-TELI / TC-QELI lamps. Die-cast ceiling trim, white powder-coated, adjustable without tool using, fixed via bayonet lock. Housing made of galvanised sheet steel. C/w toolless exchangeable remote gear box. Reflector made of high-polished metalised pure aluminium. A later supplies of the luminaire with decor glasses is possible without using tools.
Max. weight: 2,2 kg



Version	High frequency ballast (HF)	Analogue dimmable HF ballast (1-10V)	Digital dimmable HF ballast (DALI)	Diameter	Ceiling cut-out	Recessed height	Socket type
TC-TEL 42 W	255.31.42.63	255.31.42.64	255.31.42.66	255 mm	238 mm	300 mm	GX24q
TC-TEL 57 W	255.31.57.63	255.31.57.64	255.31.57.66	255 mm	238 mm	300 mm	GX24q
TC-TELI 60 W	255.31.60.63			255 mm	238 mm	300 mm	GX24q
TC-TELI 85 W	255.31.85.63			255 mm	238 mm	300 mm	GX24q

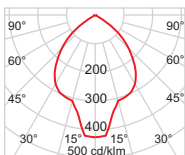
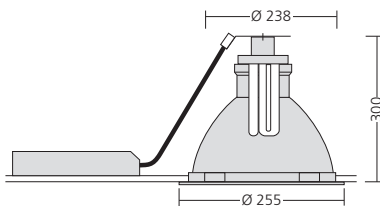

TC-TEL 57 W
Half-value angle 2 x 39°
Shielding angle 38°
Critical radiation angle/1000 cd/m² 55°
Light output ratio 68%

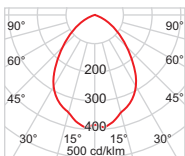

TC-TELI 85 W
Half-value angle 2 x 40°
Shielding angle 31°
Critical radiation angle/1000 cd/m² 85°
Light output ratio 76%

Attachments (Please order separately!)

Panel sheet module 100	255.0320
Mineral fibre reinforcing plate	255.1320
Adjusting ring	255.2010
Plaster ring	255.2020
Ring for semi-recessed (25 mm)	255.2025
Emergency light socket for one lamp	255.0531
Emergency light kit 1h*	255.0901
Emergency light kit 3h*	255.0900
Ceiling trim chrome	255.3020
Ceiling trim fine steel optic	255.3220
Ceiling trim special colour	255.3090

* LED supplied loose and is only on request assembled to luminaire.

Decor attachment (You will find a detailed decor attachment description on pages 381 up to 387!)





DL 255 modular

Round modular recessed downlight for TC-DEL / TC-TEL lamps

Round modular recessed downlight for TC-DEL / TC-TEL lamps. Die-cast ceiling trim, white powder-coated, adjustable without tool using, fixed via bayonet lock. Housing made of galvanised sheet steel. C/w toolless exchangeable remote gear box. Reflector made of high-polished metalised pure aluminium. VDU application suitable acc. to European Standards EN 12464-1. A later supplies of the luminaire with decor glasses is possible without using tools. Max. weight: 1,8 kg

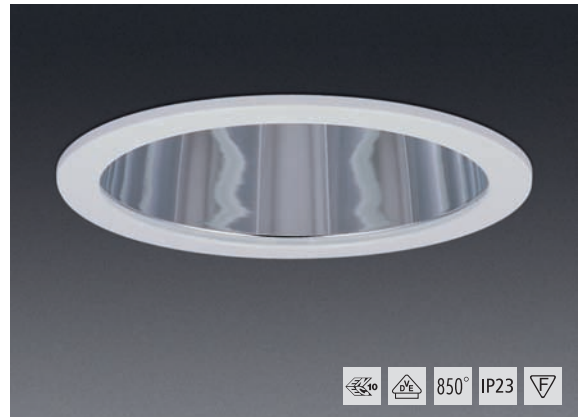

Version	High frequency ballast (HF)	Analogue dimmable HF ballast (1-10V)	Digital dimmable HF ballast (DALI)	Diameter	Ceiling cut-out	Recessed height	Socket type
TC-DEL / TC-TEL 26 W	255.51.26.53	255.51.26.54	255.51.26.56	255 mm	238 mm	165 mm	G24q
TC-TEL 32 W	255.51.32.63	255.51.32.64	255.51.32.66	255 mm	238 mm	165 mm	GX24q
TC-TEL 42 W	255.51.42.63	255.51.42.64	255.51.42.66	255 mm	238 mm	165 mm	GX24q
TC-DEL / TC-TEL 2 x 18 W	255.52.18.53	255.52.18.54	255.52.18.56	255 mm	238 mm	165 mm	G24q
TC-DEL / TC-TEL 2 x 26 W	255.52.26.53	255.52.26.54	255.52.26.56	255 mm	238 mm	165 mm	G24q
TC-TEL 2 x 32 W	255.52.32.63	255.52.32.64	255.52.32.66	255 mm	238 mm	165 mm	GX24q

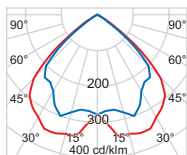
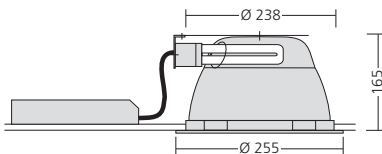

TC-DEL 2 x 26 W
 Half-value angle 2 x 48°
 Shielding angle 31°
 Critical radiation angle/1000 cd/m² 60°
 Light output ratio 78%

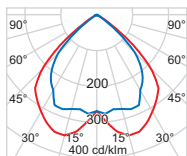

TC-TEL 2 x 32 W
 Half-value angle 2 x 48°
 Shielding angle 31°
 Critical radiation angle/1000 cd/m² 60°
 Light output ratio 68%

Attachments (Please order separately!)

Panel sheet module 100	255.0320
Mineral fibre reinforcing plate	255.1320
Adjusting ring	255.2010
Plaster ring	255.2020
Ring for semi-recessed (25 mm)	255.2025
Concrete casting drum	255.2035
Light tight module	255.4001
Emergency light socket for one lamp	255.0551
Emergency light socket for two lamps	255.0552
Emergency light kit 1h*	255.0901
Emergency light kit 3h*	255.0900
Ceiling trim chrome	255.3020
Ceiling trim fine steel optic	255.3220
Ceiling trim special colour	255.3090

* LED supplied loose and is only on request assembled to luminaire.

Decor attachment (You will find a detailed decor attachment description on pages 381 up to 387!)





DL 255 modular – Cross louvre

Round modular recessed downlight for TC-DEL / TC-TEL lamps

Round modular recessed downlight for TC-DEL / TC-TEL lamps. Die-cast ceiling trim, white powder-coated, adjustable without tool using, fixed via bayonet lock. Housing made of galvanised sheet steel. C/w toolless exchangeable remote gear box. Cross louvre reflector made of high-polished metalised pure aluminium. VDU application suitable acc. to European Standards EN 12464-1. A later supplies of the luminaire with decor glasses is possible without using tools. Max. weight: 1,9 kg



Version	High frequency ballast (HF)	Analogue dimmable HF ballast (1-10V)	Digital dimmable HF ballast (DALI)	Diameter	Ceiling cut-out	Recessed height	Socket type
TC-DEL / TC-TEL 26 W	255.41.26.53	255.41.26.54	255.41.26.56	255 mm	238 mm	165 mm	G24q
TC-TEL 32 W	255.41.32.63	255.41.32.64	255.41.32.66	255 mm	238 mm	165 mm	GX24q
TC-TEL 42 W	255.41.42.63	255.41.42.64	255.41.42.66	255 mm	238 mm	165 mm	GX24q
TC-DEL / TC-TEL 2 x 18 W	255.42.18.53	255.42.18.54	255.42.18.56	255 mm	238 mm	165 mm	G24q
TC-DEL / TC-TEL 2 x 26 W	255.42.26.53	255.42.26.54	255.42.26.56	255 mm	238 mm	165 mm	G24q
TC-TEL 2 x 32 W	255.42.32.63	255.42.32.64	255.42.32.66	255 mm	238 mm	165 mm	GX24q

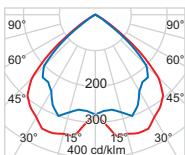
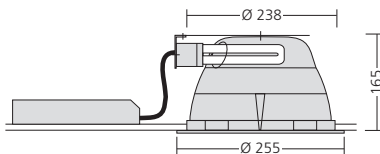

TC-DEL 2 x 26 W
 Half-value angle 2 x 43°
 Shielding angle 35°
 Critical radiation angle/1000 cd/m² 60°
 Light output ratio 60%

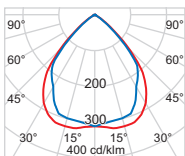

TC-TEL 2 x 32 W
 Half-value angle 2 x 43°
 Shielding angle 35°
 Critical radiation angle/1000 cd/m² 60°
 Light output ratio 57%

Attachments (Please order separately!)

Panel sheet module 100	255.0320
Mineral fibre reinforcing plate	255.1320
Adjusting ring	255.2010
Plaster ring	255.2020
Ring for semi-recessed (25 mm)	255.2025
Concrete casting drum	255.2035
Light tight module	255.4001
Emergency light socket for one lamp	255.0541
Emergency light socket for two lamps	255.0542
Emergency light kit 1h*	255.0901
Emergency light kit 3h*	255.0900
Ceiling trim chrome	255.3020
Ceiling trim fine steel optic	255.3220
Ceiling trim special colour	255.3090

* LED supplied loose and is only on request assembled to luminaire.

Decor attachment (You will find a detailed decor attachment description on pages 381 up to 387!)



255.901 / 255.912



DL 255 modular – Radial louvre

Round modular recessed downlight for TC-DEL / TC-TEL lamps

Round modular recessed downlight for TC-DEL / TC-TEL lamps. Die-cast ceiling trim, white powder-coated, adjustable without tool using, fixed via bayonet lock. Housing made of galvanised sheet steel. C/w remote gear box. Radial louvre reflector made of high-polished metalised pure aluminium. VDU application suitable acc. to European Standards EN 12464-1. A later supplies of the luminaire with decor glasses is possible without using tools. Max. weight: 1,9 kg

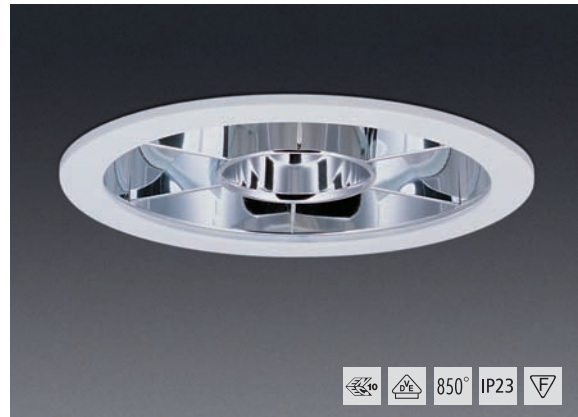

Version	High frequency ballast (HF)	Analogue dimmable HF ballast (1-10V)	Digital dimmable HF ballast (DALI)	Diameter	Ceiling cut-out	Recessed height	Socket type
TC-DEL / TC-TEL 26 W	255.81.26.53	255.81.26.54	255.81.26.56	255 mm	238 mm	165 mm	G24q
TC-TEL 32 W	255.81.32.63	255.81.32.64	255.81.32.66	255 mm	238 mm	165 mm	GX24q
TC-TEL 42 W	255.81.42.63	255.81.42.64	255.81.42.66	255 mm	238 mm	165 mm	GX24q
TC-DEL / TC-TEL 2 x 18 W	255.82.18.53	255.82.18.54	255.82.18.56	255 mm	238 mm	165 mm	G24q
TC-DEL / TC-TEL 2 x 26 W	255.82.26.53	255.82.26.54	255.82.26.56	255 mm	238 mm	165 mm	G24q
TC-TEL 2 x 32 W	255.82.32.63	255.82.32.64	255.82.32.66	255 mm	238 mm	165 mm	GX24q

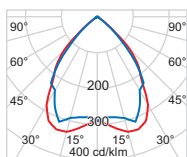
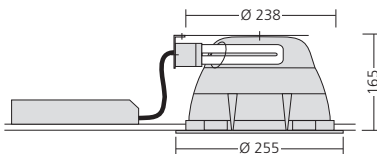

TC-DEL 2 x 26 W
 Half-value angle 2 x 41°
 Shielding angle 43°
 Critical radiation angle/1000 cd/m² 55°
 Light output ratio 57%

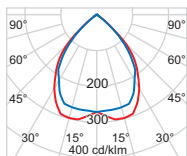

TC-TEL 2 x 32 W
 Half-value angle 2 x 42°
 Shielding angle 43°
 Critical radiation angle/1000 cd/m² 55°
 Light output ratio 49%

Attachments (Please order separately!)

Panel sheet module 100	255.0320
Mineral fibre reinforcing plate	255.1320
Adjusting ring	255.2010
Plaster ring	255.2020
Ring for semi-recessed (25 mm)	255.2025
Concrete casting drum	255.2035
Light tight module	255.4001
Emergency light socket for one lamp	255.0541
Emergency light socket for two lamps	255.0542
Emergency light kit 1h*	255.0901
Emergency light kit 3h*	255.0900
Ceiling trim chrome	255.3020
Ceiling trim fine steel optic	255.3220
Ceiling trim special colour	255.3090

* LED supplied loose and is only on request assembled to luminaire.

Decor attachment (You will find a detailed decor attachment description on pages 381 up to 387!)



255.901 / 255.912



DL 255 modular – Recessed height 135 mm

Round modular recessed downlight for TC-DEL / TC-TEL lamps

Round modular recessed downlight for TC-DEL / TC-TEL lamps with reduced recessed height. Die-cast ceiling trim, white powder-coated, adjustable without tool using, fixed via bayonet lock. Housing made of galvanised sheet steel. C/w toolless exchangeable remote gear box. Reflector made of high-polished metalised pure aluminium. VDU application suitable acc. to European Standards EN 12464-1. A later supplies of the luminaire with decor glasses is possible without using tools. Max. weight: 1,8 kg

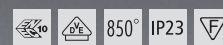
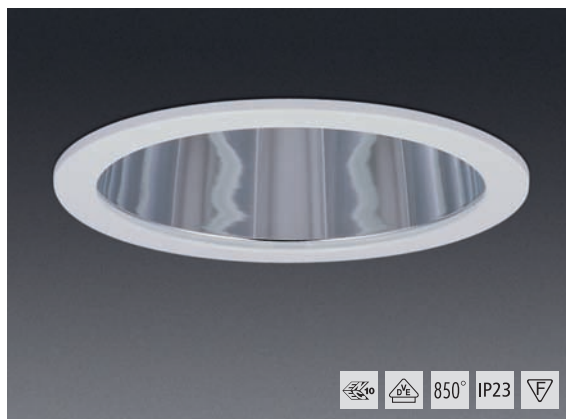

Version	High frequency ballast (HF)	Analogue dimmable HF ballast (1-10V)	Digital dimmable HF ballast (DALI)	Diameter	Ceiling cut-out	Recessed height	Socket type
TC-DEL / TC-TEL 26 W	255.21.26.53	255.21.26.54	255.21.26.56	255 mm	238 mm	135 mm	G24q
TC-TEL 32 W	255.21.32.63	255.21.32.64	255.21.32.66	255 mm	238 mm	135 mm	GX24q
TC-TEL 42 W	255.21.42.63	255.21.42.64	255.21.42.66	255 mm	238 mm	135 mm	GX24q
TC-DEL / TC-TEL 2 x 18 W	255.22.18.53	255.22.18.54	255.22.18.56	255 mm	238 mm	135 mm	G24q
TC-DEL / TC-TEL 2 x 26 W	255.22.26.53	255.22.26.54	255.22.26.56	255 mm	238 mm	135 mm	G24q
TC-TEL 2 x 32 W	255.22.32.63	255.22.32.64	255.22.32.66	255 mm	238 mm	135 mm	GX24q

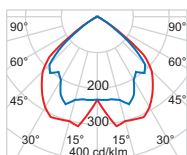
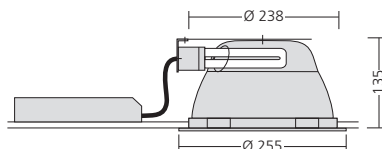

TC-DEL 2 x 26 W
 Half-value angle 2 x 50°
 Shielding angle 26°
 Critical radiation angle/1000 cd/m² 85°
 Light output ratio 72%

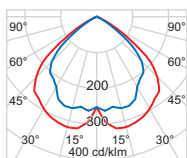

TC-TEL 2 x 32 W
 Half-value angle 2 x 50°
 Shielding angle 26°
 Critical radiation angle/1000 cd/m² 65°
 Light output ratio 71%

Attachments (Please order separately!)

Panel sheet module 100	255.0320
Mineral fibre reinforcing plate	255.1320
Adjusting ring	255.2010
Plaster ring	255.2020
Ring for semi-recessed (25 mm)	255.2025
Concrete casting drum	255.2037
Light tight module	255.4001
Emergency light socket for one lamp	255.0521
Emergency light socket for two lamps	255.0522
Emergency light kit 1h*	255.0901
Emergency light kit 3h*	255.0900
Ceiling trim chrome	255.3020
Ceiling trim fine steel optic	255.3220
Ceiling trim special colour	255.3090

* LED supplied loose and is only on request assembled to luminaire.

Decor attachment (You will find a detailed decor attachment description on pages 381 up to 387!)

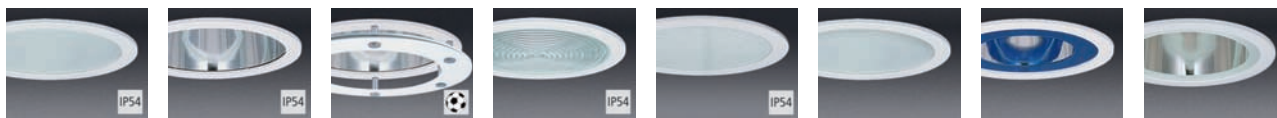

255.900 / 255.928 255.901 / 255.912 255.952 255.925 255.937 255.935 255.930 255.932



255.903 255.904 255.909 255.922 255.923 255.934 255.982



DL 255 modular – Recessed height 95 mm

Round modular recessed downlight for TC-DEL / TC-TEL lamps

Flat modular recessed downlight for TC-DEL / TC-TEL lamps. Die-cast ceiling trim, white powder-coated, adjustable without tool using, fixed via bayonet lock. Housing made of galvanised sheet steel. C/w tool-less exchangeable remote gear box. Reflector made of high-polished metalised pure aluminium. A later supplies of the luminaire with decor glasses is possible without using tools. Max. weight: 1,7 kg



Version	High frequency ballast (HF)	Analogue dimmable HF ballast (1-10V)	Digital dimmable HF ballast (DALI)	Diameter	Ceiling cut-out	Recessed height	Socket type
TC-DEL / TC-TEL 18 W	255.71.18.53	255.71.18.54	255.71.18.56	255 mm	238 mm	95 mm	G24q
TC-DEL / TC-TEL 26 W	255.71.26.53	255.71.26.54	255.71.26.56	255 mm	238 mm	95 mm	G24q
TC-DEL / TC-TEL 2 x 18 W	255.72.18.53	255.72.18.54	255.72.18.56	255 mm	238 mm	95 mm	G24q
TC-DEL / TC-TEL 2 x 26 W	255.72.26.53	255.72.26.54	255.72.26.56	255 mm	238 mm	95 mm	G24q

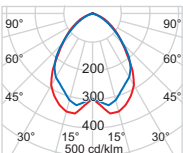
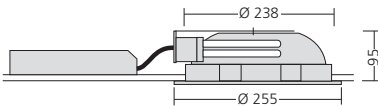

TC-DEL 2 x 18 W
 Half-value angle 2 x 42°
 Shielding angle 14°
 Critical radiation angle/1000 cd/m² 70°
 Light output ratio 73%

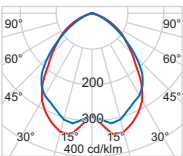

TC-DEL 2 x 26 W
 Half-value angle 2 x 45°
 Shielding angle 14°
 Critical radiation angle/1000 cd/m² 75°
 Light output ratio 78%

Attachments (Please order separately!)

Panel sheet module 100	255.0320
Mineral fibre reinforcing plate	255.1320
Adjusting ring	255.2010
Plaster ring	255.2020
Concrete casting drum	255.2037
Emergency light socket for one lamp	255.0571
Emergency light socket for two lamps	255.0572
Emergency light kit 1h*	255.0901
Emergency light kit 3h*	255.0900
Ceiling trim chrome	255.3020
Ceiling trim fine steel optic	255.3220
Ceiling trim special colour	255.3090

* LED supplied loose and is only on request assembled to luminaire.

Decor attachment (You will find a detailed decor attachment description on pages 381 up to 387!)





DL 255 modular – asymmetrical

Round modular recessed downlight for TC-DEL / TC-TEL lamps

Round modular recessed downlight for TC-DEL / TC-TEL lamps for asymmetrical light distribution. Die-cast ceiling trim, white powder-coated, adjustable without tool using, fixed via bayonet lock. Housing made of galvanised sheet steel. C/w toolless exchangeable remote gear box. Asymmetrical reflector made of high-polished metalised pure aluminium. A later supplies of the luminaire with decor glasses is possible without using tools. Max. weight: 1,9 kg

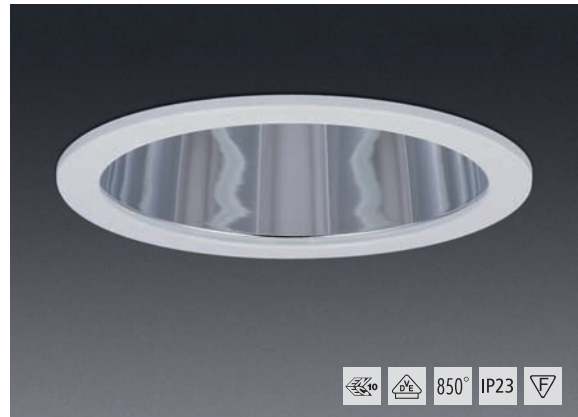

Version	High frequency ballast (HF)	Analogue dimmable HF ballast (1-10V)	Digital dimmable HF ballast (DALI)	Diameter	Ceiling cut-out	Recessed height	Socket type
TC-DEL / TC-TEL 18 W	255.11.18.53	255.11.18.54	255.11.18.56	255 mm	238 mm	165 mm	G24q
TC-DEL / TC-TEL 26 W	255.11.26.53	255.11.26.54	255.11.26.56	255 mm	238 mm	165 mm	G24q
TC-TEL 32 W	255.11.32.63	255.11.32.64	255.11.32.66	255 mm	238 mm	165 mm	GX24q
TC-DEL / TC-TEL 2 x 18 W	255.12.18.53	255.12.18.54	255.12.18.56	255 mm	238 mm	165 mm	G24q
TC-DEL / TC-TEL 2 x 26 W	255.12.26.53	255.12.26.54	255.12.26.56	255 mm	238 mm	165 mm	G24q

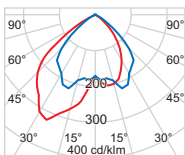
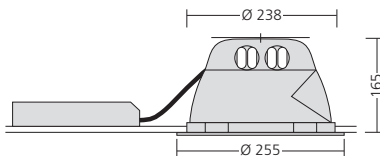

TC-DEL 2 x 18 W
 Half-value angle 52 / 26°
 Shielding angle 31°
 Critical radiation angle/1000 cd/m² 60°
 Light output ratio 55%

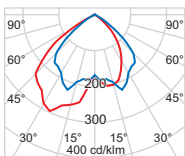

TC-DEL 2 x 26 W
 Half-value angle 54 / 30°
 Shielding angle 31°
 Critical radiation angle/1000 cd/m² 65°
 Light output ratio 57%

Attachments (Please order separately!)

Panel sheet module 100	255.0320
Mineral fibre reinforcing plate	255.1320
Adjusting ring	255.2010
Plaster ring	255.2020
Ring for semi-recessed (25 mm)	255.2025
Concrete casting drum	255.2035
Light tight module	255.4001
Emergency light socket for one lamp	255.0551
Emergency light socket for two lamps	255.0552
Emergency light kit 1h*	255.0901
Emergency light kit 3h*	255.0900
Ceiling trim chrome	255.3020
Ceiling trim fine steel optic	255.3220
Ceiling trim special colour	255.3090

* LED supplied loose and is only on request assembled to luminaire.

Decor attachment (You will find a detailed decor attachment description on pages 381 up to 387!)



255.901 / 255.912



DL 255 modular – Radial louvre

Round modular recessed downlight for TC-DEL / TC-TEL / LV lamps

Round modular recessed downlight for TC-DEL / TC-TEL lamps with separately wired low voltage lamp QR-CBC 51 up to 50 Watt. Die-cast ceiling trim, white powder-coated, adjustable without tool using, fixed via bayonet lock. Housing made of galvanised sheet steel. C/w remote gear box. Radial louvre reflector made of high-polished metalised pure aluminium. C/w transformer 34.060. Max. weight: 2,0 kg



Version	High frequency ballast (HF)	Analogue dimmable HF ballast (1-10V)	Digital dimmable HF ballast (DALI)	Diameter	Ceiling cut-out	Recessed height	Socket type
TC-DEL / TC-TEL 2 x 18 W	255.82.18.03	255.82.18.04	255.82.18.06	255 mm	238 mm	165 mm	G24q
TC-DEL / TC-TEL 2 x 26 W	255.82.26.03	255.82.26.04	255.82.26.06	255 mm	238 mm	165 mm	G24q

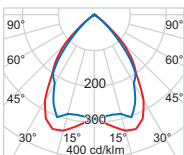
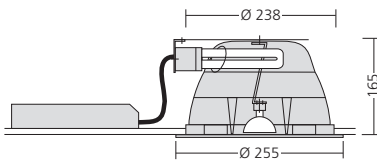

TC-D 2 x 18 W without QR-CBC 51
 Half-value angle 2 x 40°
 Shielding angle 43°
 Critical radiation angle/1000 cd/m² 56°
 Light output ratio 56%

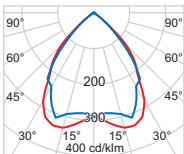

TC-D 2 x 26 W without QR-CBC 51
 Half-value angle 2 x 40°
 Shielding angle 43°
 Critical radiation angle/1000 cd/m² 58°
 Light output ratio 51%

Attachments (Please order separately!)

Panel sheet module 100	255.0320
Mineral fibre reinforcing plate	255.1320
Adjusting ring	255.2010
Plaster ring	255.2020
Ring for semi-recessed (25 mm)	255.2025
Concrete casting drum	255.2035
Emergency light socket for two lamps	255.0542
Emergency light kit 1h*	255.0901
Emergency light kit 3h*	255.0900
Ceiling trim chrome	255.3020
Ceiling trim fine steel optic	255.3220
Ceiling trim special colour	255.3090

* LED supplied loose and is only on request assembled to luminaire.